

CANTON



R
REFERENCE

2024



Epochal sound quality

Made in Germany

If you want to create new worlds of sound, you have to know where you are coming from and where you want to go. And you must know which paths you must take to reach your goal.

With the Reference Series, we have created an intricately built masterpiece in which every detail has been carefully thought through and implemented at the highest level. Innovative materials - carefully selected, refined and perfected - meet perfect craftsmanship. For a sound quality that meets even the highest demands. In countless listening sessions, sound by sound, finally emerged

what defines the Reference series today: limitless listening pleasure. And also visually we're taking our Reference Series to a new level. The cabinet has numerous sweeping curves on all sides, making the elegant design a real statement.

A quality product Made in Germany that sets new standards in terms of craftsmanship and sound. Made with great attention to detail and a passion for music, these speakers will inspire you. Experience the perfect listening experience and let Canton's number one series take you to new worlds of sound.

Contents

Products	4
Shaping	20
In Detail	22

Development	24
Home Cinema	27
Technical Data	28
Colour Variants	30



Reference 1 Iconic Sound

Imposing, powerful and true to their shape - that's the new Reference 1. Equipped with the most modern technology we have to offer in loud-speaker construction, it sets the standard for the future. This powerful sound artist is a masterpiece of engineering and meets perfection in craftsmanship with its new design. The flawless surface finish combined with our best speaker drivers make them a true musical statement.

3 900 000 ₺

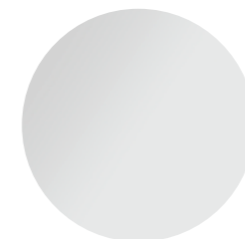

White Satin

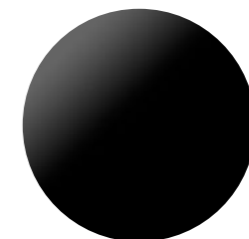

Black Piano

Dimensions: W 39 × H 133 × D 63 cm

Reference 2

Pure aesthetics

As an imposing 3-way floorstanding speaker, the Reference 2 has the potential to provide exceptional and uncompromising listening pleasure even in very large rooms. With the benefit of smaller proportions compared to the flagship of the series, they are perfect for reference level stereo reproduction and of course they are also an excellent choice for home cinema applications.

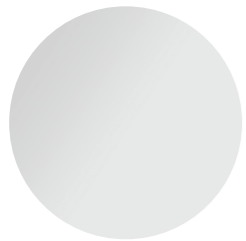

White Satin

3 100 000 ₺

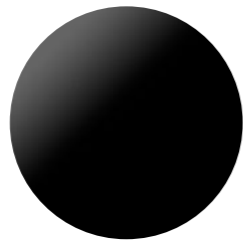

Black Piano

3 100 000 ₺



Walnut

3 500 000 ₺

Dimensions: W 35 × H 116 × D 53 cm





Reference 3

Powerful elegance

Experience your music in a new way - these floorstanding speakers are a revelation in medium-sized rooms. Individual facets of the music are reproduced naturally and precisely in every detail. The edge-free design characterises all speakers in the series and ensures an attractive appearance. It also forms the basis for perfect sounds with authentic image and clear graduation of the music.

2 600 000 ₺

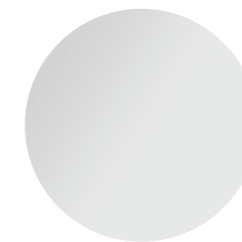

White Satin

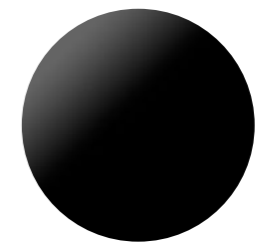

Black Piano

Dimensions: W 32 × H 109 × D 49 cm



Reference 5

Puristic – Modern

Immerse yourself in a new era of sound with the Reference 5 and let the medium-sized floorstanding speakers thrill you. The perfectly shaped design, in keeping with "Form Follows Function", makes no compromises. They're bursting with resolution and playability, while premium materials and components and the latest technology ensure that your music sounds vibrant and natural.

1 700 000 ₺



White Satin

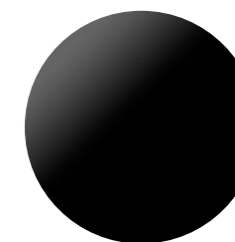

Black Piano

Dimensions: W 30 × H 101 × D 46 cm



Reference 7 Breathtaking

Pure aesthetics, breathtaking performance – as the slimmest floorstanding speakers in the Reference series, the Reference 7 blend harmoniously into any room. In terms of sound, they deliver high level stability, out-standing bass reproduction and perfect imaging characteristics. With their compact design, they round off the floorstanding speakers of the Reference model series.

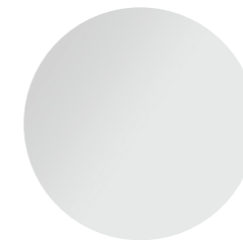

White Satin

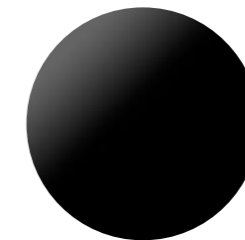

Black Piano



Walnut

1 300 000 ₺

1 300 000 ₺

1 400 000 ₺

Dimensions: W 28 × H 98 × D 43 cm

Reference 9

Sound miracle

Our knowledge from over 50 years of loudspeaker construction combined in compact and acoustically pristine speakers – the Reference 9. Equipped with the technologies of a floorstanding speaker, they offer the potential to fill larger rooms thanks to the large mid-bass driver. As compact speakers, they can be placed on a sideboard or on the optional Reference LS stand (available in black matt and black high gloss). No matter where they are placed, they deliver powerful performance and impressive music reproduction.

700 000 ₺

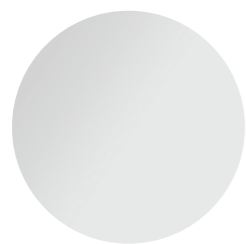

White Satin

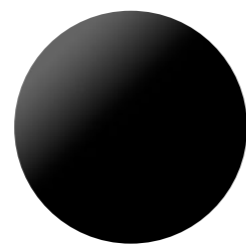

Black Piano

Dimensions: W 26 × H 45 × D 39 cm



Reference Center Crystal clear sound

The ideal addition to your home cinema system: expand your Reference speakers with the Reference Center and immerse yourself into new, thrilling worlds of sound. Perfectly matched to the Reference series in terms of design and technology, you can keep an eye on everything, even in the most exciting films. The 3-way speaker offers accurate, authentic dialogue reproduction and, thanks to its 3-chamber construction with bass guide, can reproduce deep tones precisely and powerfully. The Reference Center can be placed on a sideboard, or freestanding on the optionally available Reference Center LS stand (available in black matt and black high gloss).

600 000 ₺

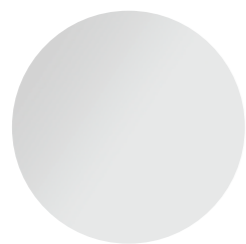

White Satin

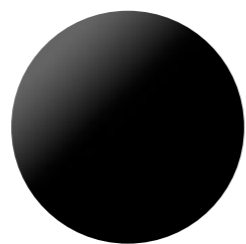

Black Piano

Dimensions: W 70 × H 27 × D 39 cm





Reference Sub

Deeply impressive

With the Reference Sub you can add a powerful active subwoofer to your Reference speakers. With its large enclosure volume, the front-firing subwoofer, with integrated downfire passive cone, offers unparalleled dynamic bass reproduction. Due to its precise performance and the use of our best Canton technologies, it is perfectly suited to complement stereo systems and provide ideal low-frequency support for home cinema systems.

800 000 ₺



White Satin

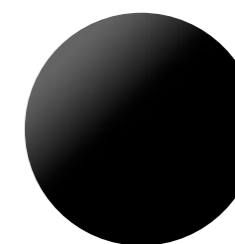

Black Piano

Dimensions: W 49 × H 59 × D 53 cm

Perfection down the smallest detail



The shape. A statement.

For the completely new Reference Series cabinets, we have designed round baffles for the first time, which are manufactured on a 5-axis CNC milling machine specially provided for this purpose. The elaborately curved side panels, backs and lids ensure significantly reduced self-resonance. The optimised enclosures with their sweeping curves offer the most homogeneous radiation characteristics. In keeping with our ever-high standards, the cabinets have no mounted baffle, but are fully lacquered and set new standards in stability with their solid multi-layer laminate construction.

Imposing. Strongly contoured. Timeless.

The elaborate cabinet shape of the new Reference speakers has been optimised to deliver impressive sound experiences. The clear advantage: an elegant appearance, with living room-friendly dimensions that will amaze you visually and acoustically.



Elaborate internal stiffening

To control the enormous forces inside the Reference speakers, a special computer-optimised stiffening is required. The careful selection of the baffle shape and additional, precisely defined damping made of special fleece prevents standing waves inside the cabinets.



Optimised bass guide

All Reference Series speakers use the latest generation Bass Guide. Low-frequency signal components are reproduced precisely and evenly from the cabinet to the front and rear, with increased efficiency. In addition, the special geometric design reduces airflow noise and thus increases flexibility in the choice of setup location.

The technology

Meticulous. Thoughtful. Perfect.

The development of the crossover is not only about splitting the sound signals, but also about sound-shaping measures. Optimally designed, it extends the frequency response and improves the group delay in the interaction of the drivers. A few hand-picked components with minimal tolerance specifications ensure a balanced impedance curve and perfect impulse behaviour.



Powerful crossovers

With the help of Displacement Control, the crossover prevents uncontrolled deflection of the woofers and increases the bandwidth using the same cabinet size. As a result, an enormously precise bass is achieved even at the highest sound pressure. As the control centre of the loudspeakers, the newly developed crossovers make a decisive contribution to stress-free music enjoyment at all levels. They ensure brilliant highs, impressive bass and the highest precision in the fundamental range.



WBT connection terminals

The WBT connection terminals nextgen™ used set a new standard for optimal signal transmission. As a basis, the high-quality connection terminals made of the low-damping material POM provide an outstanding solution for audiophile applications and contribute to precise sound reproduction.



Level adjustment

Thanks to the integrated mid-treble adjustment, all floorstanding speakers, as well as the centre, can be adapted to the room acoustics and individual listening tastes. As 2-way compact speakers, the Reference 9 offer tweeter adjustment.



High-end cabling

The cable length of the specially produced Canto-Link 400 cables inside the enclosures are reduced to a minimum. The construction with a special core and six twisted individual conductors ensures optimum signal transmission from the connection terminal to the chassis.



Powder-coated appliance feet

The CNC-turned feet, made in Germany from high-quality steel and with a noble black powder coating, provide ideal black powder coating, in conjunction with a special rubber pad, provide ideal decoupling and combine stability with audiophile quality.



Sealing ring

The newly developed flocked sealing ring for loudspeaker drivers ensures effective decoupling and, with its exceptional attention to detail, contributes to an impressive listening experience.

Attention to detail

Innovative. Precise.

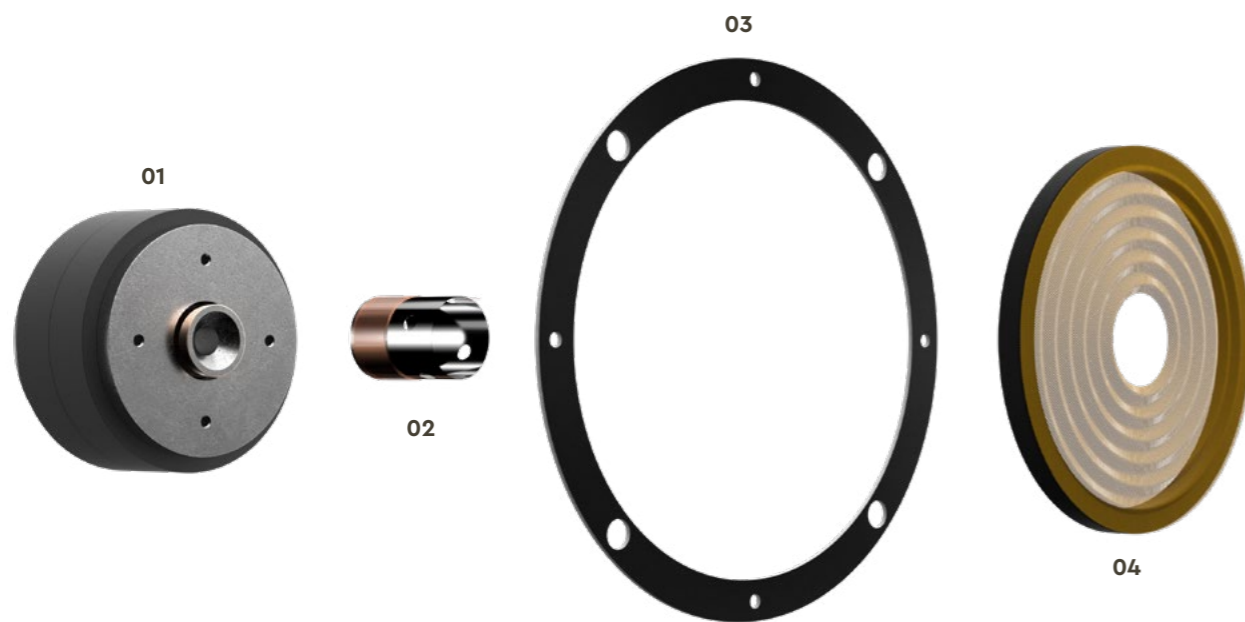

- 1. Magnet:** The coil (2) is embedded in a balanced inductive field through the targeted power and structural optimisation of the magnet drive with a pole core bore.
- 3. Sealing ring:** Newly developed sealing rings, placed between the loudspeaker cabinet and chassis, offer targeted damping for precise sound transmission thanks to their special flocking.
- 4. Centring spider:** An optimised centring spider with a precisely defined number of springs forms the connection between the coil carrier and the basket.
- 5. Speaker basket:** Fibreglass-reinforced polycarbonate baskets combine remarkable lightness with great stability, making them an optimal choice for a wide variety of applications.

New materials for the best sound

No other material meets our demands for a perfect diaphragm like the new BCT diaphragm. For the first time in the Reference series, we use this material in the low and midrange. This guarantees neutral, dynamic and lifelike sound.

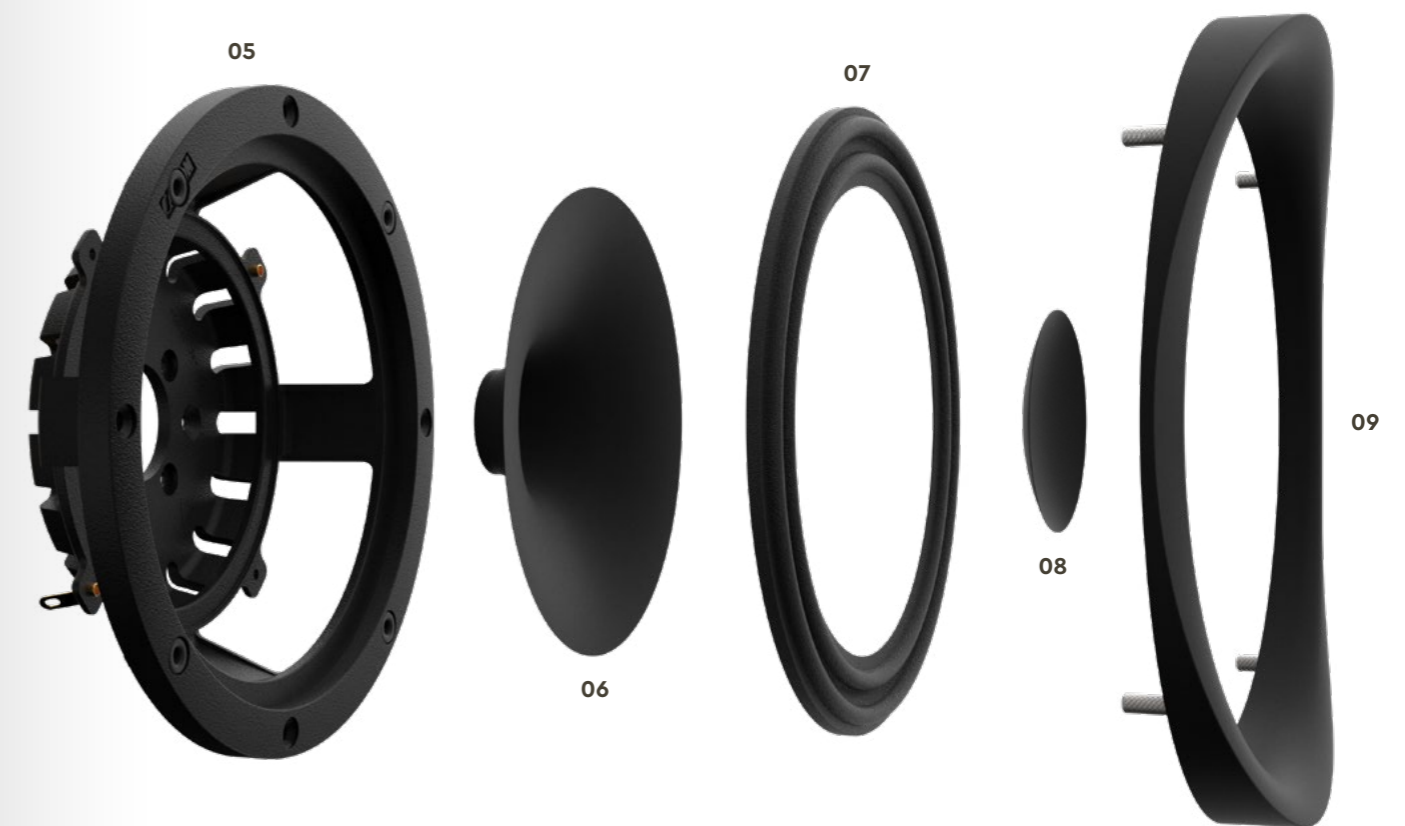

- 6. TCC diaphragm:** The midrange systems of the new Reference Series use a shape-optimised diaphragm with three different radii.
- 7. Wave surround:** The clamping of the oscillation system, which is designed as a wave surround, enables enormous stroke movements and precisely controls the inward and outward oscillation behaviour.
- 8. Dust cap:** The dust cap seals the oscillation system and optimally transfers the heat produced by the coil.
- 9. Cover rings:** The amorphously shaped front ring made of the low-resonance material POM, serves as an asymmetrical waveguide and additionally increases the mechanical stability of the oscillating system.

Material vs. technology

Highest quality standards



BCT diaphragm and wave surround technology

To achieve the perfect stiffness-to-weight ratio, the BCT diaphragms of the low- and mid-range systems are made of an aluminium cone converted into a 25% ceramic structure on both sides and then refined with tungsten and other metal particles. The specially shaped black midrange ceramic cone in TCC technology also stabilises the diaphragm and reduces unwanted resonance and distortion.

In addition, the latest generation of wave surrounds is used. Three congruent bead arcs guarantee a balanced symmetry of forces that ensures even transient response even at higher levels and cone excursions. This is achieved with the same utilisation of the area and weight of the oscillating system.



BC domes

The crystal-clear highs of the Reference tweeter systems are achieved by using extremely light and stiff BC domes. The special shape of the new asymmetrical wave guide optimises dispersion both in the crossover range and in the high-frequency range above 15,000 Hz. The BC domes help to create immersive listening experiences where even the finest nuances and details in the music can be experienced.



POM

With the first use of the high-molecular, thermoplastic POM, another quality material has found its way into our new Reference series. POM is characterised above all by its high rigidity, excellent acoustic damping behaviour and good dimensional stability. The fine-pored, silk-matt surface is additionally coated with a thin layer of lacquer to ensure even greater resistance. For us, the only right choice for manufacturing the precision parts used in the Reference series.



Surround specialists

for great emotions

The Reference Series speakers are perfect for building impressive home theatre systems. The new 3-way center speaker serves as the heart of the system and, together with the other Reference Series speakers, makes every concert recording and action film a true audio experience. The precision tuning of the speaker components ensures immersive sound quality, while the elegant cabinet design adds to the aesthetic appeal of your home theatre space. Enjoy an exceptional audiovisual experience in your own home with the Reference Series.

Subwoofer

The Reference subwoofer's powerful digital power amplifier, with an impressive 750 watts for audiophile enjoyment, has both a high- and low-level input. The high-quality woofer system produces impressive bass down to 18 Hz, contributing to an intense soundstage.



Pure technology Everything at a glance

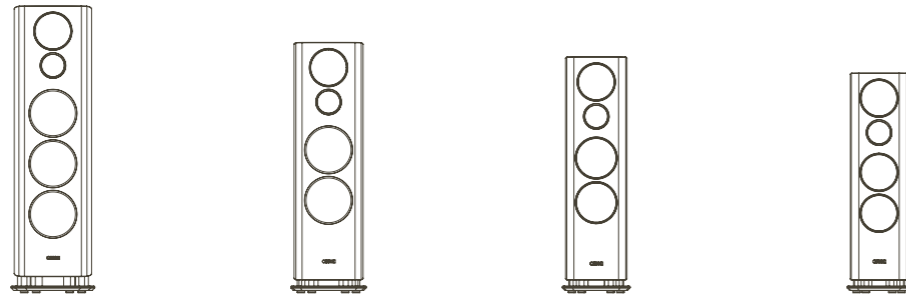

REFERENCE 1 REFERENCE 2 REFERENCE 3 REFERENCE 5

Usage	High-end floorstanding speaker	High-end floorstanding speaker	High-end floorstanding speaker	High-end floorstanding speaker
Principle	3-way, bass reflex system	3-way, bass reflex system	3-way, bass reflex system	3-way, bass reflex system
Nominal/ music load capacity	450 / 820 W	370 / 630 W	300 / 500 W	200 / 370 W
Driver size				
Woofer system	3 × 219 mm	2 × 219 mm	2 × 192 mm	2 × 174 mm
Mid-woofer system	-	-	-	-
Midrange system	1 × 174 mm	1 × 174 mm	1 × 174 mm	1 × 174 mm
Tweeter system	1 × 25 mm	1 × 25 mm	1 × 25 mm	1 × 25 mm
Passive diaphragm	-	-	-	-
Efficiency (2,83 V / 1 m)	88 dB	88 dB	88 dB	88 dB
Transmission range	18...40.000 Hz	19...40.000 Hz	20...40.000 Hz	21...40.000 Hz
Transition frequency	170 / 3.100 Hz	160 / 3.000 Hz	180 / 3.000 Hz	170 / 3.000 Hz
Impedance	4...8 Ohm	4...8 Ohm	4...8 Ohm	4...8 Ohm
Dimensions (W × H × D with base)	39 × 133 × 63 cm	35 × 116 × 53 cm	32 × 109 × 49 cm	30 × 101 × 46 cm
Weight	81 kg	62 kg	42 kg	36 kg
* optional speaker stand	-	-	-	-

3 900 000 ₺ ● 3 100 000 ₺ 2 600 000 ₺ 1 700 000 ₺
 ○ 3 100 000 ₺
 ● 3 500 000 ₺

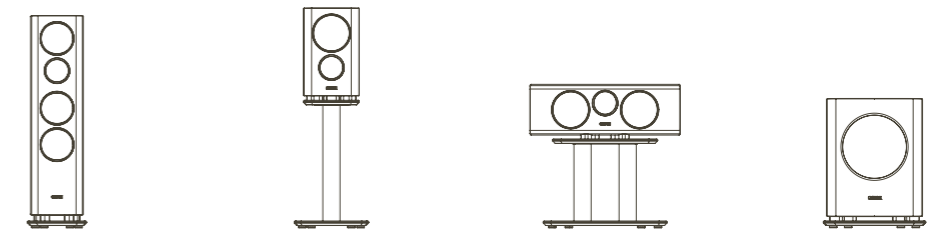

REFERENCE 7 *REFERENCE 9 *REFERENCE CENTER REFERENCE SUB

Usage	High-end floorstanding speaker	High-end compact loudspeaker	High-end center loudspeaker	High-end subwoofer
Principle	3-way, bass reflex system	2-way, bass reflex system	3-way, bass reflex system	Bass reflex system with passive diaphragm
Nominal/ music load capacity	160 / 320 W	125 / 220 W	130 / 230 W	500 / 750 W
Driver size				
Woofer system	2 × 154 mm	-	1 × 174 mm	1 × 308 mm
Mid-woofer system	-	1 × 174 mm	-	-
Midrange system	1 × 154 mm	-	1 × 174 mm	-
Tweeter system	1 × 25 mm	1 × 25 mm	1 × 25 mm	-
Passive diaphragm	-	-	-	1 × 308 mm
Efficiency (2,83 V / 1 m)	87,5 dB	87 dB	88 dB	-
Transmission range	23...40.000 Hz	25...40.000 Hz	25...40.000 Hz	18...200 Hz
Transition frequency	190 / 3.200 Hz	2.900 Hz	160 / 2.900 Hz	55...200 Hz (adjustable)
Impedance	4...8 Ohm	4...8 Ohm	4...8 Ohm	-
Dimensions (W × H × D with base)	28 × 98 × 43 cm	26 × 45 × 39 cm	70 × 27 × 39 cm	49 × 59 × 53 cm
Weight	33 kg	18 kg	26 kg	37 kg
* optional speaker stand	-	Reference LS	Reference Center LS	-

● 1 300 000 ₺ 700 000 ₺ 600 000 ₺ 800 000 ₺
 ○ 1 300 000 ₺
 ● 1 400 000 ₺

Variants

Surfaces for every Taste



White Satin

Black Piano

Walnut

Elegant. Valuable. Noble.

The Reference Series' finishes are truly exquisite, underlining the speakers' sophisticated character. The White Satin versions require the finest base finishes in the production process and are coated with two layers of UV-resistant silk matt lacquer. The noble, high-gloss surface finish "Black Piano" is applied in twelve steps, sanded and elaborately polished. It gives the cabinets of the new Reference series an overwhelming depth effect. Last but not least, the high-quality walnut veneer stands out with its particularly fine-pored surface. This is achieved by a special sanding technique and a matt lacquer finish. Acoustically neutral, one-piece fabric covers per driver, with high-quality magnetic fastening, nestle into the shape of the cabinet.

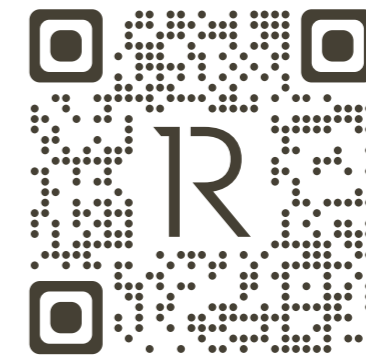

The Reference speakers in your living room

The code allows you to place the new Reference models in any room you are in using augmented reality. Just point your smartphone camera at the QR code to scan it and experience the Reference up close. How about in your living room, for example? Try it out right now! *

*Currently supported by the following devices: iPhone from iOS 12+ and Android phones from Android 8.0+ with ARCore 1.9 support

CANTON

